

Review

Hybrid Floating Solar Plant Designs: A Review

Evgeny Solomin ^{1,*}, Evgeny Sirotkin ¹, Erdem Cuce ^{2,3}, Shanmuga Priya Selvanathan ⁴
and Sudhakar Kumarasamy ^{1,5,6,*}

- ¹ Department of Electric Power Stations, Network and Supply Systems, South Ural State University, 76 Prospekt Lenina, 454080 Chelyabinsk, Russia; ea.sirotkin@gmail.com
 - ² Department of Mechanical Engineering, Faculty of Engineering, Recep Tayyip Erdogan University, Zihni Derin Campus, Rize 53100, Turkey; erdem.cuce@erdogan.edu.tr
 - ³ Low/Zero Carbon Energy Technologies Laboratory, Faculty of Engineering, Recep Tayyip Erdogan University, Zihni Derin Campus, Rize 53100, Turkey
 - ⁴ Department of Chemical Engineering, Manipal Institute of Technology, Manipal Academy of Higher Education, Manipal 576104, India; shan.priya@manipal.edu
 - ⁵ Faculty of Mechanical and Automotive Engineering Technology, Universiti Malaysia Pahang (UMP), Pekan 26600, Malaysia
 - ⁶ Energy Centre, Maulana Azad National Institute of Technology, Bhopal 462003, India
- * Correspondence: solominev@susu.ru (E.S.); sudhakar@ump.edu.my (S.K.)

Abstract: The world's demand for electricity will double by 2050. Despite its high potential as an eco-friendly technology for generating electricity, solar energy only covers a small percentage of the global demand. One of the challenges is associated with the sustainable use of land resources. Floating PV (FPV) plants on water bodies such as a dam, reservoir, canal, etc. are being increasingly developed worldwide as an alternative choice. In this background, the purpose of this research is to provide an outline of the hybrid floating solar system, which can be used to generate renewable energy. The hybrid technologies discussed include: FPV + hydro systems, FPV + pumped hydro, FPV + wave energy converter, FPV + solar tree, FPV + tracking, FPV + conventional power, FPV + hydrogen. The review also summarizes the key benefits and constraints of floating solar PV (FPV) in hybrid operation. Among the various hybrid FPV technologies, with solar input and hydro energy were among the most promising methods that could be potentially used for efficient power generation. The valuable concepts presented in this work provide a better understanding and may ignite sustainable hybrid floating installations for socio-economic growth with less environmental impact.

Keywords: hybrid; solar; floating PV; design; operational context



Citation: Solomin, E.; Sirotkin, E.; Cuce, E.; Selvanathan, S.P.; Kumarasamy, S. Hybrid Floating Solar Plant Designs: A Review. *Energies* **2021**, *14*, 2751. <https://doi.org/10.3390/en14102751>

Academic Editors: Dimitrios Katsaprakakis and Evgeny V. Solomin

Received: 13 April 2021

Accepted: 7 May 2021

Published: 11 May 2021

Publisher's Note: MDPI stays neutral with regard to jurisdictional claims in published maps and institutional affiliations.



Copyright: © 2021 by the authors. Licensee MDPI, Basel, Switzerland. This article is an open access article distributed under the terms and conditions of the Creative Commons Attribution (CC BY) license (<https://creativecommons.org/licenses/by/4.0/>).

1. Introduction

The demands for energy, land for agricultural purposes, and shelter have increased tremendously with the ever-growing population. With the depletion of non-renewable resources like coal and oil, it is imminent that we switch over to renewable sources of energy. Most regions across the globe are blessed with at least one commercially viable source of renewable energy (wind, solar, hydro, geothermal), and others have several such renewable sources. Solar energy is widely regarded as the most abundant and infinite source of energy on the planet [1]. Large-scale photovoltaic energy deployment necessitates the use of a substantial amount of land resources [2]. The overall impact of conventional PV implementations is of higher magnitude due to various project-related activities like deforestation, bird mortality, erosion, runoff, and microclimate change [3]. The average land use for a ground-based PV power plant is 0.5–0.7 MWp/ha [4]. However, with the limited availability of land and the associated cost, solar plants are hard to deploy, especially in densely populated countries [5]. Solar plants are often built on agricultural lands and wastelands which is not a truly sustainable use of land resources. PV panels have a negative temperature coefficient, which means that the sunlight to energy conversion performance

of the panels improves as the temperature drops [6]. Floating solar PV (FPV) is a novel application in which solar arrays are mounted over water bodies to take advantage of the negative thermal coefficient of the solar module [7]. Because of the numerous advantages of FPV, water may become a new prime focus for solar siting [8].

FPV and airport-based installations provide new avenues for increasing solar generating capacity, particularly in land-locked countries and competing land uses [9]. It may become a more economical solution than buying costly land for PV deployment. Floatovoltaics have been installed in several countries which include the United States, Japan, China, Korea, India, Brazil, Singapore, Norway, and the United Kingdom. Floating solar could be especially useful in areas where grids are poor, such as sub-Saharan Africa and parts of developing Asia [10]. One of the most significant challenges, however, is that solar PV projects require cooling as panel heat reduces electrical performance [11]. The floating photovoltaic (FPV) utilizes the principle of exploiting large water surfaces for energy generation and managing the plant with water as a cooling medium [12].

Waterbodies that are not used for recreation or tourism, such as wastewater treatment plants, fish ponds, hydroelectric reservoirs, industrial ponds, and lagoons, are ideal for FPV application [13]. In Japan, the most floating PVs have been installed over water reservoirs, with power generation ranging from 4 kW to 20 MW [6]. Several large-scale projects are also increasingly developed in the last few years.

Independent variables such as air temperature (T_a), solar irradiance (G_t), wind speeds (V_w), and water temperature (T_w) affect the FPV system's energy yield [14]. For this reason, a floating platform made from high-density polyethylene (HDPE) can be used. The evaporation can be reduced by as much as 70%, thereby saving water as well [1]. Also, the power gain is increased by about 6% due to the backwater cooling of the PV [14]. The measured temperature difference between the lake and land is about 1–3 °C.

Installing solar panels on water costs about 15% more than installing them on land [15]. The reduction of floating construction costs and the rising growth in developing countries suggest that the FPV sector will experience rapid deployment [16]. Various insights about the commercial design of FPV were also presented in the literature [17]. The higher costs of floating solar are offset by the natural water-cooling effect, which can make the module more effective partially and extend their lifetimes [18]. The energy gain from the cooling of FPV systems was estimated to be between 3% and 6% when compared to reference PV systems tested in two different climate zones [19]. The favorable regions for the installation of FPV are the locations with abundant water bodies such as canals, lakes, reservoirs, dams, and ponds, and suitable climate [20,21]. However, sea salt accumulation on PV systems decreases power production and performance [22].

The application of a floating solar system in aquaculture is discussed as a potential solution to address the issue of food-water-energy nexus [23]. Several design solutions of FPV systems to increase efficiency and cost-effectiveness are described [24]. A technically feasible and economically viable photovoltaic floating cover system is proposed as an alternative solution for the agricultural industry with a solution to fully cover the reservoir to reduce evaporation losses [25]. A novel system for producing electricity with FPV modules and heating water with solar energy for water ponds in the mining industry has been investigated [26]. FPV technology is significantly more effective than land-based technology as it offers several co-benefits [27]. The module temperature of FPV is normally lower than 5–10 °C differences compared to other environment resulting in 10% increase in efficiency [28]. An innovative concept for varying the azimuth angle of the FPV with a fixed tilt resulted in a 27.68% increase in power production over a standard floating PV system [29].

A method to investigate the tracking-type FPV had been discussed which includes suitable area assessment, water depth, shade, solar distribution, and flow modeling [30].

The installation of solar panels on the ocean surface is inspired by the constrained onshore available land and the offshore area surrounding the island nations [31].

The techno-economic aspects of photovoltaic (PV) systems in offshore environments were studied [32]. The effect of wave motion and direction on offshore PV output is demonstrated theoretically [33]. The societal, environmental and sustainable aspects of solar systems must be carefully evaluated before large-scale adoption [34].

Scientists have proposed the energy potential of combining floating solar facilities with existing hydropower infrastructure, assessing that these hybrid plants can be operated flexibly. Considering the recent developments in hybrid technology, there is a need to understand the technical and beneficial aspects of the HFPV plants.

In this context, this study aims to analyze the various options of hybridizing the floating photovoltaic (HFPV) systems. The different design options of the HFPV system and the resulting features based on the current state-of-the-art are the focus of this review. The paper further evaluates the benefits and constraints of HFPV technology.

The outline of the study is highlighted in Figure 1. The paper is organized as follows: Section 2 focuses on solar PV in the water environment. Section 3 summarizes the concept of hybridization, key drivers, and components of the HFPV plant. Section 4 focuses on the different designs of the HFPV system. Section 5 summarizes the potential, recent developments, and industrial players in HFPV. Section 6 summarizes the positive implications, constraints, and special considerations of the HFPV power plants. Finally, Section 7 provides a conclusion and future outlook of the study.

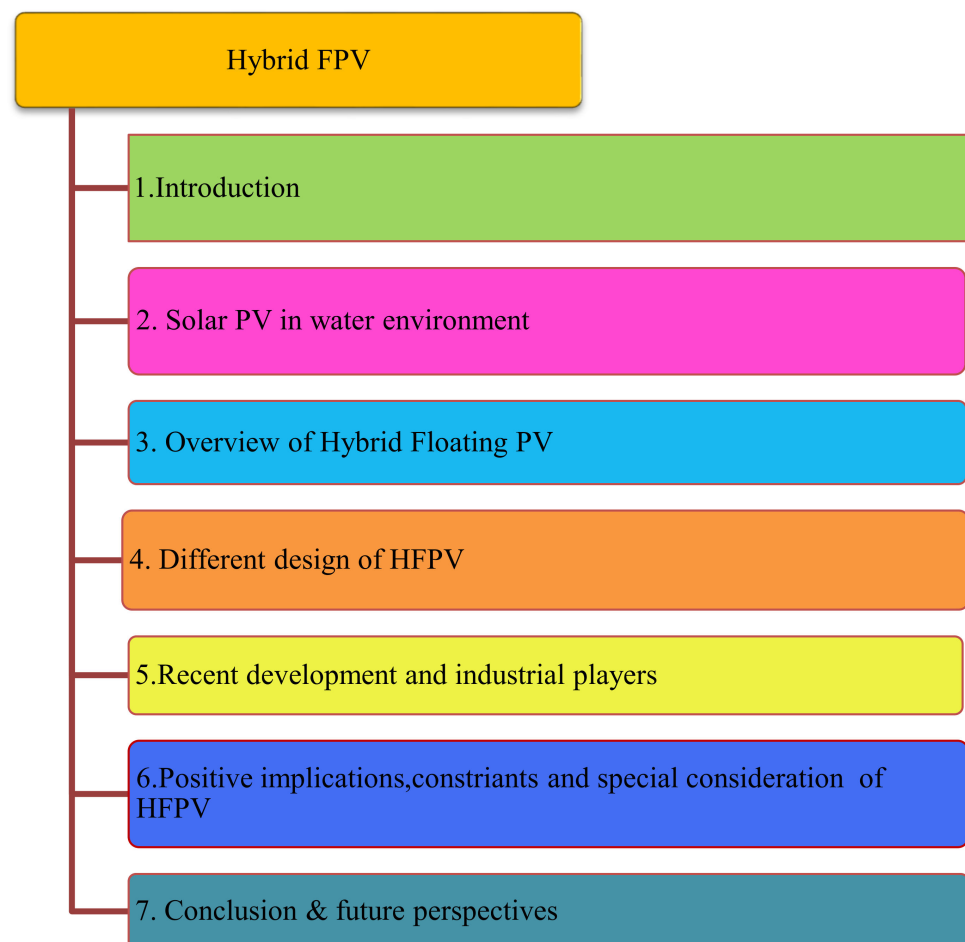

Figure 1. Outline of the HFPV review.

2. Solar PV in Water Environment

The classification of Solar PV in waterbodies is presented is shown in Figure 2.

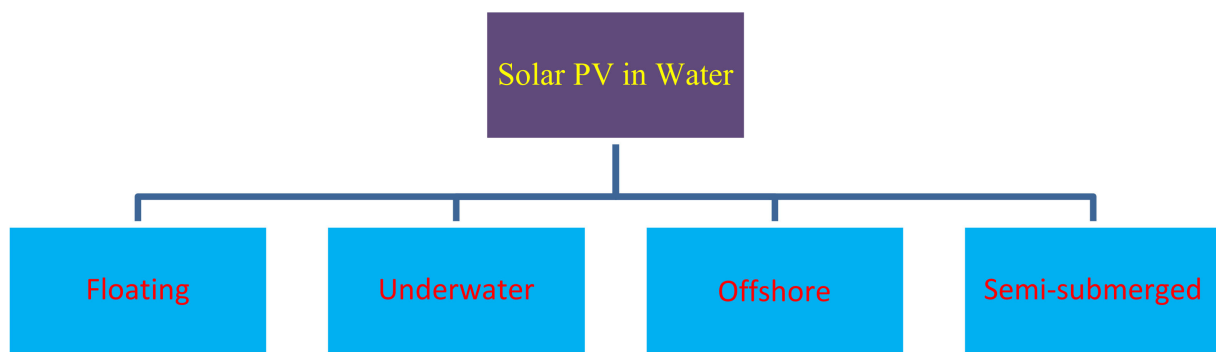

Figure 2. Classification of PV in water environment.

2.1. Floating PV (FPV)

Floating photovoltaics is a typical solar technology that involves mounting solar panels over natural or man-made bodies of water rather than placement on terrestrial systems [35,36]. FPV systems are classified into three major groups based on their supporting structures: (1) Fixed Tilt arrays: rigid pontoons are required; (2) Tracking: it can be installed with or without pontoon; and (3) Flexible arrays: Due to the low weight, no supporting structure in the form of the pontoon is needed; FPV can also be classified based on the scale of implementation: small scale (few kW), medium scale (kW to MW) and large scale (MW to GW) [37]. Based on the different supporting structure designs of FPV systems, it can be classified as fixed floating PV systems [38], floating-tracking PV systems [39], and cooled FPV systems [40]. Floating-tracking PV systems have greater net capital costs than fixed floating PV systems, but they generate more electricity [41].

2.2. Underwater/Submerged/Semi-Submerged

PV modules in deep and shallow water are proposed as a solution for cleaning panels, reducing reflection losses and efficiency improvement by elimination of thermal drift [42]. This system can be used to power underwater devices, as well as swimming pools and decorative pools and fountains [42]. The submerged photovoltaic solution is effective in low latitude locations (i.e., lower than 30 °C where tilt angle is less than 20 °C) where both ambient temperature and irradiance levels are quite high throughout the year [43]. Semi-submerged solutions with both flexible and rigid structures were designed and tested on a small-scale solution with thin-film panels [44,45].

2.3. Offshore/Marine Environment

Half of the Earth's population lives in proximity to a coast, and three-quarters of the world's large cities are situated by the sea. Offshore PV power generation is the concept of applying the FPV system in oceans and seas to harvest solar energy [46]. FPV designs in offshore conditions are different from the standard lakes owing to the harsh waves caused by the strong winds [47]. Offshore PV is an ideal solution for load centers' because it eliminates the need for long-distance power transmission from other areas [48,49]. This can provide a short path from production to consumption. Due to higher relative humidity and wind speeds, the temperature at sea was much lower at the floating installation [33]. The design and material selection of the offshore system is evaluated based on wind-driven wave heights. Saltwater corrosion, the need for a suitable anchoring system, and wave heights are the major technical challenges with the offshore PV system.

3. Hybrid Floating Photovoltaic System

3.1. Overview of Hybridization

A "hybrid energy" system is intended to harness energy from multiple sources including both renewable and conventional power plants at the same time and location. In this context, a hybrid renewable energy system (HRES) is linked in the same system to improve

system performance and energy supply balance. Hybridization of floating solar with other variable renewables increases the energy density of the device to a degree that is higher than that of other renewable power systems, and in some cases can even compete with fossil fuels.

The main advantages of hybrid system:

- Grid connectivity (via transmission lines, transformers, and so on) makes the system more reliable.
- Additional source enhances the reliability and productivity of the existing system;
- When used in tandem as a hybrid, water resources, and solar energy can compensate for each other [50].

3.2. Key Drivers of Hybrid FPV

The several factors which drive the development of the Hybrid FPV are compiled in Table 1.

Table 1. Some key drivers of hybrid floating solar plants.

Serial Number	Description of the Drivers
1	Adequate sunshine on water surface than on land.
2	Water covers two-thirds of the Earth's surface.
3	Other energy sources like Hydropower supplies about 20% of the world's electricity
4	Increasing cost and non-availability of land for commercial deployment
5	High land footprint and potential environmental impact with a land-based PV system
6	Low-capacity utilization of Hydropower plants and less efficiency of land-based solar PV plants
7	Specific challenges of Island nations to meet energy demand
8	The variability of energy production caused by the intermittent nature of solar
9	Problems with electrical transmission grid's stability with one source.
10	Water-energy nexus

3.3. Classification of Hybrid FPV

Figure 3 illustrates the classification of the Hybrid FPV.

3.4. Technological Components of FPV and Hybrid Floating Solar Plants (HFPV) System

A floating device, mooring system, PV modules, DC/AC cables, and connectors make up the FPV system [51]. Modular design, reliability, durability, protection, optimum support structure size, easy installation, and cost reduction are seven factors that may indicate whether or not an FPV system is optimally constructed [52]:

- (a) Floating structure (pontoon): The PV system is installed on a floating body (floater and structure) in the case of an FPV system [3]. It provides the necessary buoyant force to keep the whole system floating [53]. Floaters are commonly made of high-density polyethylene (HDPE) or medium density polyethylene (MDPE) [54].
- (b) Mooring System: The floating structure is held securely with a permanent structure. This halts the free movement of the floating structure in water. The mooring system uses anchors and cables to keep the floating system stable [55]. It can also respond to water level variations while retaining its southward location preventing modules from drifting away or shifting position [56]. A mooring system consists of a mooring string, anchor, and connections and is used to hold a floating platform stationed in any depth of water [57]. An anchor on the seafloor is connected to a floating structure by a mooring line [58].

- (c) PV system: Floating photovoltaic (FPV) systems, which are made up of single or multiple crystalline-based photovoltaic (PV) modules [59] mounted on a buoyant platform, are typically intended to be arranged in an array on the surface of a closed body of water. In an FPV system, solar energy is converted into electrical energy using PV modules and other power conditioning equipment [60]. Standard PV modules used in land-based PV systems can be used, but research is being conducted to develop specific flexible PV modules for floating applications [61]. There has been increasing interest in the development of thin film-based solar cells.
- (d) Cables and connectors: The electricity generated by the PV system is typically transferred to the substation through underground cables. These cables could be extended underwater or via the floaters, but they could also be used as floating cables [62]. This forms an important link between the grid and the solar panel. Due to its usage underwater cables should be shack proof or leakage proof [63]. The inverters are mounted on the shore side, much like a traditional ground-based system.
- (e) Basin: A basin that contains water from the first with a second floating system that serves to bring the same volume of water consumed by the hydroelectric turbines daily through solar pumps, this allows an annual use of the same volume of water without losses.
- (f) Other Energy sources: The energy sources like wind, ocean thermal energy conversion (OTEC), hydro, pumped hydro, hydrogen, etc. are considered for the HFPV system.

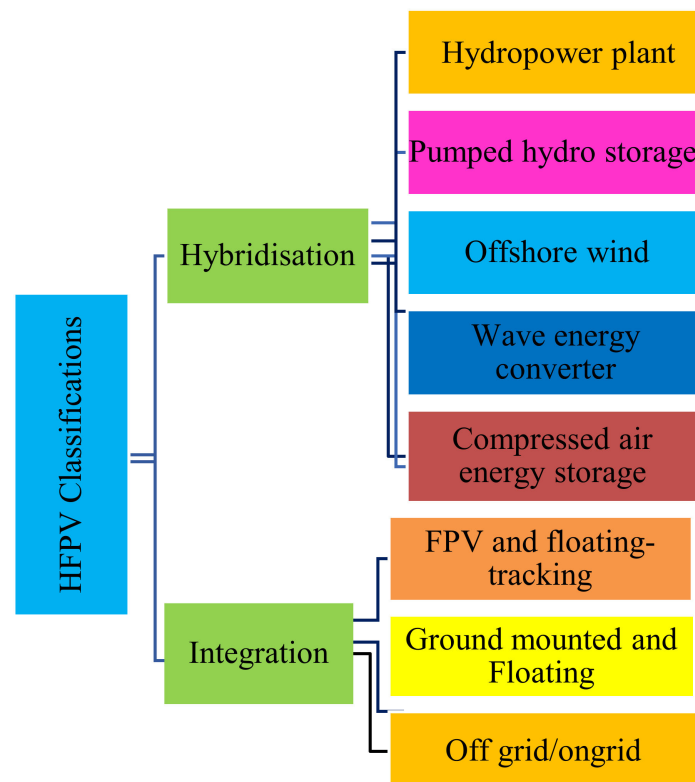

Figure 3. Classification of HFPV (Modified from [50]).

4. An Overview of Various Designs of Hybrid FPV Technologies

4.1. Floating PV + Wind

Solar and wind are well known and fast-growing technologies across the world. However, the concept of hybrid wind and floating solar farms remains largely unexplored (Figure 4). In this renewable offshore energy farm, the combined wind farm and FPV would increase the power generation per unit surface area of marine space. Unlike wind energy, solar energy production is expected to be consistent across the study region [64]. As

a result, deep-water power plants are not be expected to increase solar energy output—a benefit of offshore PV farms over offshore wind farms. Due to the wide space between turbines in an offshore wind park and the current or planned cable capacity to connect the wind park to the grid on land, integrating floating PV into such a wind park may be a viable option [65].

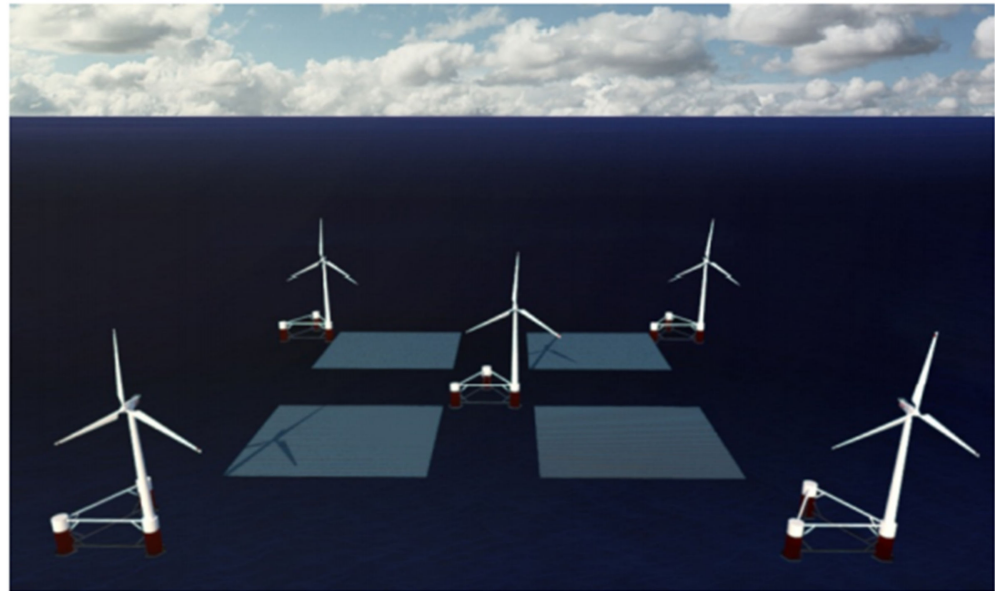

Figure 4. Schematic of combined floating wind and solar energy farm [64].

4.2. Floating PV + Hydro + Wind

Hybrid projects combining floating solar panels and hydropower plants have the technological capacity to produce a large portion of the world's annual electricity. HFPV is a suitable solution for a country that has a lot of hydropower plants with dams. Developers can use existing power facilities, such as transmission lines if the floating solar farm is built near hydropower plants. An innovative technology using floating solar with battery storage and hydropower was proposed for coastal regions [66]. The intermittent floating solar resource is integrated with a battery energy storage system to meet peak demands [66]. Colocation with hydropower plants will help to boost the generation of such assets and smooth out the generation curve. The addition of a floating solar system close to a reservoir's dam compensates for the unstable generation of these systems by adjusting hydropower production, while PV systems can compensate for the hydro energy shortfall in the medium to long term [67]. HFPV is flexible and complementary technology. In this case wind turbines are located in spaces surrounding the reservoirs and connected to the common electrical transmission lines [68]. The addition of a wind turbine can compensate for the unstable energy generation from both hydro and FPV. A schematic of a hybrid floating PV-hydro and wind system is shown in Figure 5.

Suitable sites: The number of hydropower installations is noticeably lower in typical dry areas (Sahara, Northern Mexico, Central America, the Persian Gulf, Australia, and so on), but they are still present. This is due to the fact that hydropower is a significant, regional resource [69]. Asia has a distinct advantage as it has the world's highest concentration of high-power dual-energy solar/hydro sites. Among the locations are rivers in Japan, Vietnam, Indonesia, and Malaysia, tidal flows in China and Korea, canals in Japan, and aqueducts in Japan and China.

Dry seasons: Solar systems have the highest efficiency during the dry seasons, while rainy seasons have the highest hydropower potential. Therefore, both technologies can complement one another. Dry seasons tend to be a less serious problem. The rafts can rest on the dry banks and may provide strength to the system until the water level is regained.

Given the amount of open surface area that reservoirs have, this is the positive way to get the most out of something that could have cost a lot in terms of displaced homes and real estate.

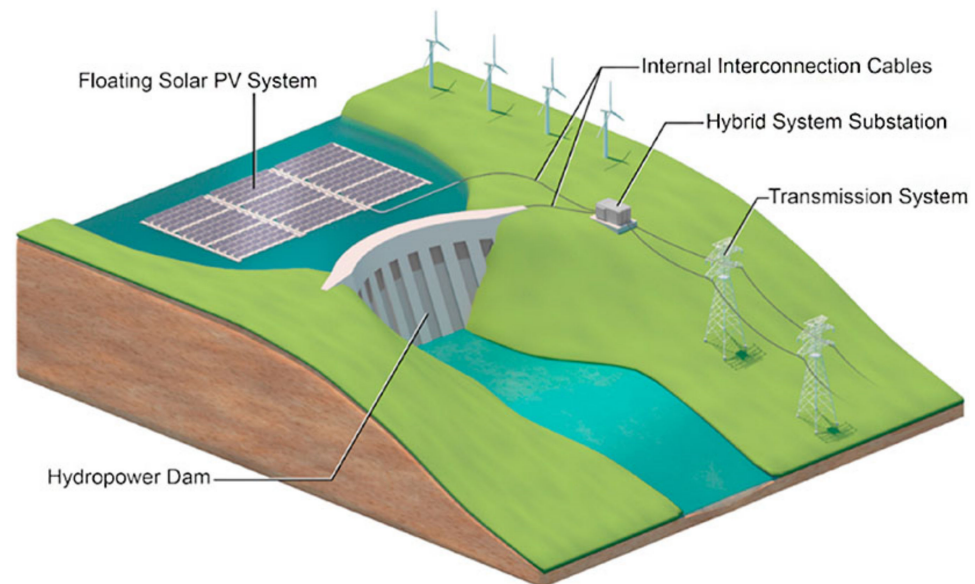

Figure 5. Schematic of a hybrid floating PV-hydropower system [68] (reprinted with permission from Elsevier).

4.3. Floating Solar PV with Pumped Hydro Energy Storage (FPV + PHES)

Pumped hydropower energy storage (PHES) was developed in the 20th century with the majority of these projects being undertaken between the 1960s and 1980s. A PHES system requires two reservoirs of varying heights, with the lower reservoir connected to a water source. PHES operations are extremely flexible due to their high flexibility, this is, of course, feasible [69]. The pumped hydro system allows for the use of solar power to pump water from the reservoir and reuse it to generate fresh hydroelectric power during times of lower demand [69]. The dams could continue to provide power in this manner but at a reduced condition. In this case, the reservoir's stored water will function as an efficient energy storage system. The operators of a hybrid system could also store the excess energy generated by solar panels using pumped-storage hydropower. A photograph of a FPV with a pumped hydro system is presented in Figure 6.

The FPV system, the PHS sub-system with upper and lower reservoirs, the AC and DC bus with appropriate power electronics converters, and the load demand, are connected to the AC bus [70]. The power produced by the FPV panels is directly transmitted to the micro-grid during times of high solar irradiation, while the reservoir either accumulates (when an inflow stream exists) or simply retains water that can be used later during times of low or absent solar irradiation [71]. The reservoir becomes a battery in this way, with the "bill" being the water that is saved from being used or accumulated when direct solar energy is used. This energy storage can be deployed with a very high capacity because dams and water reserves have no space constraints. Higher coverage ratios may be considered, depending on the reservoir's position and additional uses, to provide even more power (and electricity) while also increasing water conservation rates [72]. Simultaneously, batteries and other alternative energy storage technologies hold a significant role, and the "PHES" usefulness is restricted by the reservoir's capacity. Furthermore, supply does not always match the population center (demand). The use of irrigation facilities to store excess PV energy for a farmhouse has also been investigated [71].



Figure 6. FPV with a pumped hydro “virtual battery” concept. (Copyright EDP S.A., photo by Pixbee).

4.4. Floating + Micro-Hydrokinetic Turbines

Solar panels on the float’s topside capture the sun’s energy, while micro-hydrokinetic turbines on the bottom capture hydropower from the flowing water (Figure 7). Low-lying solar panels that float in rivers, canals, tidal flows, and aqueducts can be used. The energy generation is unit unaffected by clouds, rain, or even nightfall [73]. This one-of-a-kind combination also increases the power output of both the solar and hydro components. The floating platform also serves as a solid, stable, and cost-effective foundation for the hydrokinetic turbine array’s operation and maintenance. Finally, the units are quiet and have a low visual impact, as they leave no trace on the ground or in the water. Although the technology was proposed for canal-top projects, the design can be modified and adapted to the floating solar concept environment [73].

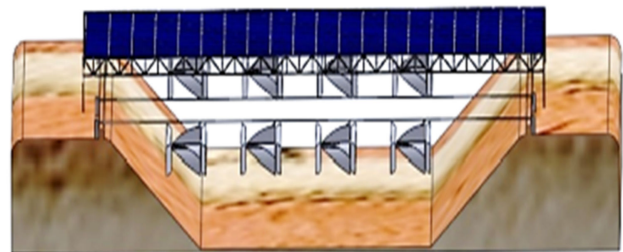

Figure 7. Floating + micro hydrokinetic concept. (Source: Bourne Energy, USA) [73].

4.5. FPV + Wind Energy System and Battery Storage

The basic concept of the systems is direct alternating current (DC) from the FPV arrays and/or wind turbines after being converted by an inverter is transmitted to the load bus through the cables bus (Figure 8). The system controller continuously regulates the load and the output from the PV and/or wind systems [74]. The electricity that can

instantly fulfill the portion of the demand is transmitted through a transformer and fed to the distribution grid to meet the load. If at any point in time there is a shortage of electricity supply to satisfy the demand that is not covered by the PV arrays and/or wind turbines, then energy is imported through a connection to the main grid. On the other hand, if at any point these systems supply any electricity that exceeds the load, this electricity is deemed to be excess electricity that is sold to the main grid. The combined renewable energy is supplemented by electricity imports.

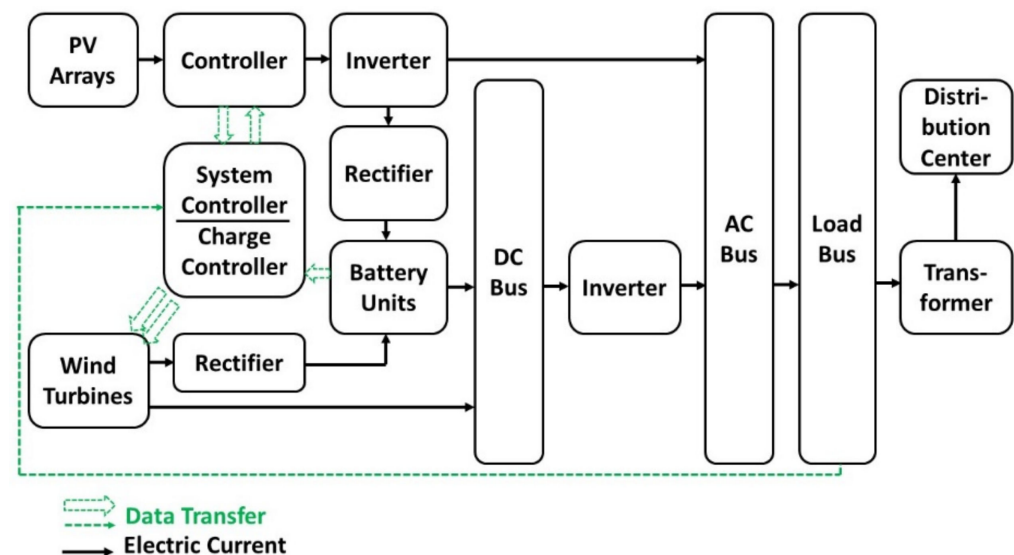

Figure 8. Schematic of FPV + wind energy system and battery storage system [74].

4.6. FPV with Compressed Air Storage

Because of their high efficiency, low environmental impact, and high energy density, compressed air energy storage systems (CAES) are one of the most feasible technological options for integration [75]. The management of the thermodynamic equilibrium is the main issue in CAES. The decision between isothermal compression, which allows for a large amount of heat exchange, and adiabatic compression, which requires efficient heat storage and recovery, is important. Isothermal compression allows a vast amount of energy to be stored [75]. The bulk of the accumulated energy, on the other hand, is transferred to the heat reservoir, ensuring that the process remains isothermal. The same holds good for the expansion process, which takes longer during the night or on cloudy days when more energy is needed. Care must be taken with the compressor and pneumatic motor, and a good heat exchanger is needed to minimize the irreversible process as much as possible [24]. The whole concept is explained in the block diagram given in Figure 9.

The flow of electric energy is highlighted by black lines, the air flow by green arrows, and the water flow by blue lines. The working principle of the FPV with CAES are explained in the following steps [75]:

- The FPV system produces electric energy through PV modules and then supplies to the grid or to the water pump through inverter;
- The water pump compress water, up to 20 MPa in a suitable storage tank where the pressurized water is used to increase the pressure of the air in pipes;
- The compressed air, stored in the floating pipes can be used to power a hydro-turbine to recover the stored energy whenever necessary [24].

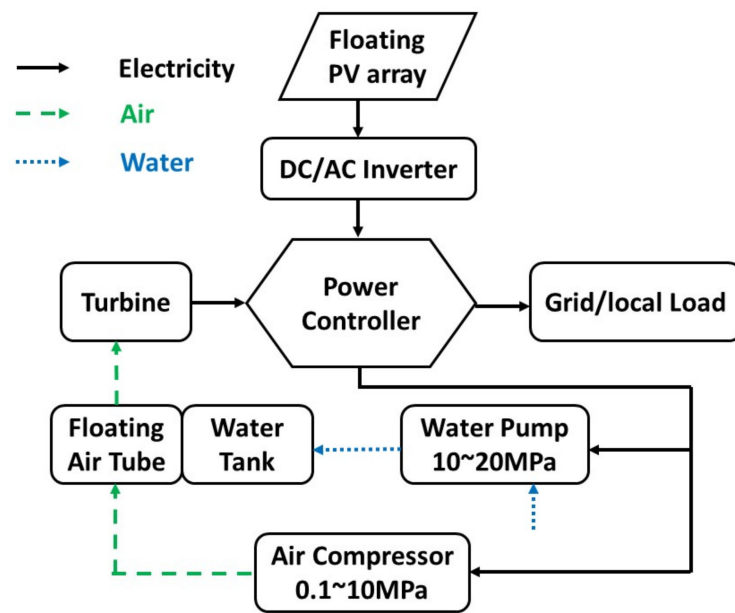

Figure 9. Block diagram of a floating PV system with compressed energy storage [75].

4.7. Hybrid Floating Solar + Wind + Ocean Energy System

Hybrid floating solar and wave energy systems are possible solutions to supply clean and sustainable energy for Island nations [76]. Optimizing the use of various marine resources can reduce deployment, maintenance, and decommissioning costs by combining devices in an integrated framework or co-locating distinct technologies in a farm layout.

Sinn Power invented the concept of a full ocean hybrid platform able to convert wave, solar, and wind energy (Figure 10). As part of an off-grid energy solution, photovoltaic arrays on a floating platform have been developed. The system is designed to be modular with ease of connection and expansion. With this flexible design, several combinations are possible. The modular design is a key component that allows for flexibility and a wide range of applications. The floating platform has the potential to provide renewable energy to islands all over the world, as well as contribute to the global deployment of offshore wind farms. Wind generators are also adopted in the design as wide-open spaces provide good wind velocity.

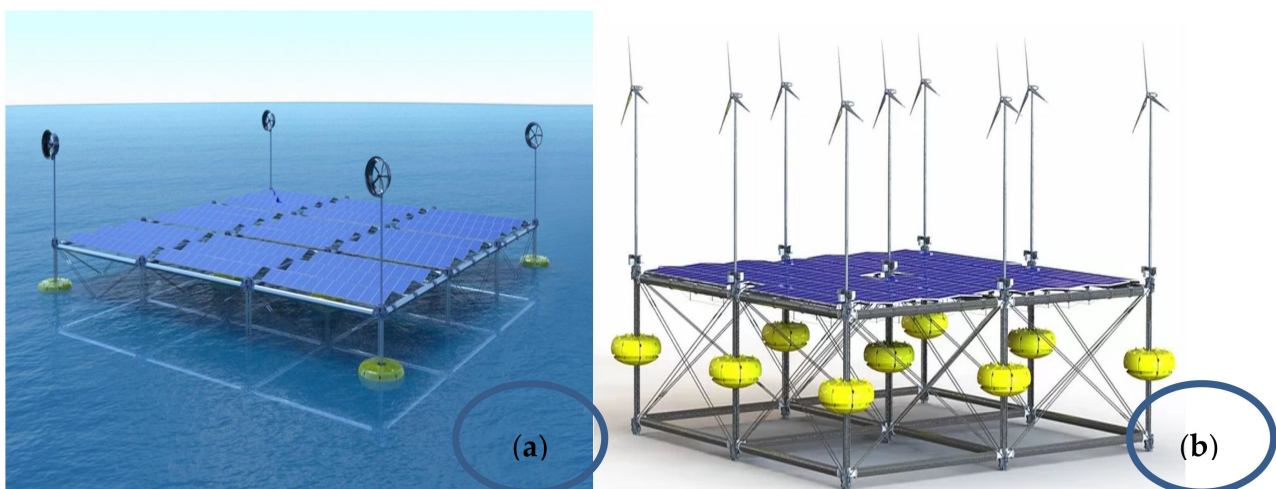

Figure 10. (a) Wave energy conversion (WEC) with floating solar (b) (WEC) with floating solar and wind (Source: Sinn Power).

The specific features of the design are:

- Heavy Duty-No Foundation
- Maximum robustness
- Scalability
- Little maintenance

4.8. Floating Solar + Waterlily (Solar Tree) Tracking

The authors provided an interesting nature-inspired idea of tracking floating systems in Italy [50]. This low-cost solution consists of a floating platform connected to the mooring chain with an underwater concrete anchor [77]. A tracking algorithm for the sun movement drives the submerged propellers which ensure the rotation. A presentation provided the innovative solution of a solar tree-based water lily design for the hydroelectric power plant which is presented in Figure 11 [77].

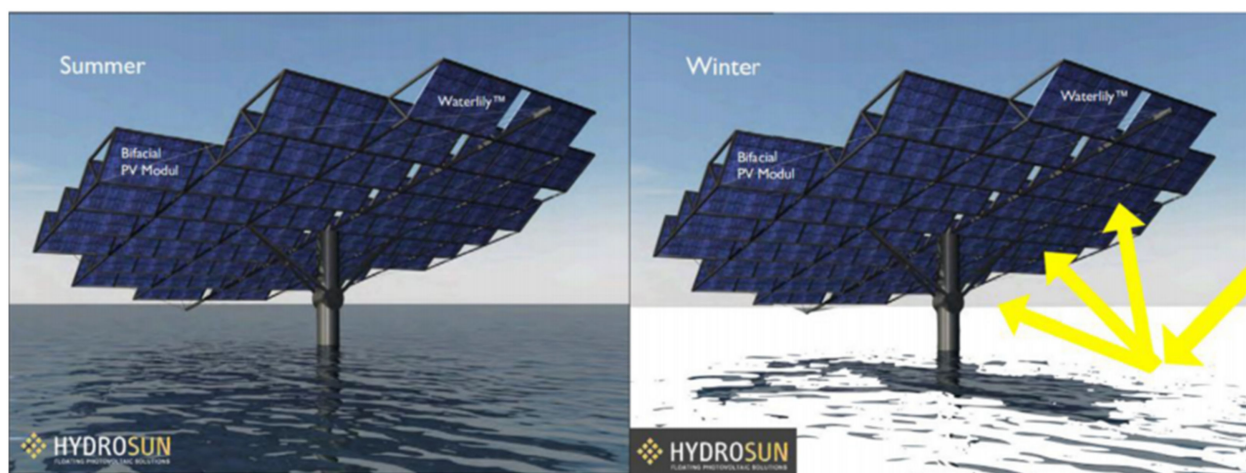

Figure 11. Nature-inspired Solar tree (waterlily design) with bifacial modules. (Source: TNC Consulting AG, Switzerland) [77].

4.9. Floating Solar Integration with Conventional Plant

The feasibility of an FPV system in conjunction with a Diesel generator (DG) and battery bank to meet the off-grid demand of an island is studied as shown in Figure 12 [78]. The feasibility of floating PV integrated with the conventional gas-fired system was analyzed [79]. Coal, gas, and fuelwood are currently the main fuels used in the district heating systems of Sarajevo canton. The new concept of reducing the consumption of fossil fuels in households' heating systems with the use of renewable electricity from the floating solar plant is proposed [79]. The cost-optimal solution for district heating using conventional and PV systems for heating electrification is suggested to promote efficient cogeneration systems [79]. A floating LNG plant (FLNG) is an ocean-based LNG plant built on a ship or barge with a natural gas-powered gas turbine, LNG storage, and offloading capabilities. A combined cycle is used to optimize plant performance, in which gas turbine exhaust gas is used to produce steam, which is then used to control the steam turbine, which develops electrical power. The floating solar plant can be integrated into the FLNG to meet the auxiliary electrical power requirements at the site. This concept of the hybrid floating power plant is feasible with floating solar and transport of natural gas (LNG carrier) to the ocean. The combination of wind, wave, and solar energy, as well as the combined cycle LNG-fueled power plant, will significantly increase output and production capacity. The FPV integration with fossil fuel plants greatly reduced the generating costs across the system [31].

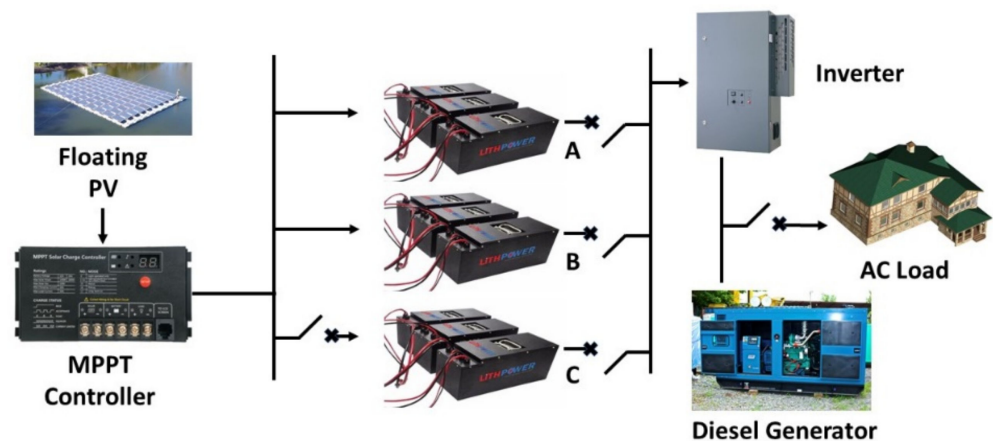

Figure 12. Schematic of a FPV/Diesel hybrid system [78].

4.10. Floating Solar Island with Hydrogen Energy Storage

Floating solar energy islands generate electricity via solar, wind, and waves, in addition to having an OTEC plant. A conceptual floating solar island is shown in Figure 13. These floating platforms are to be designed for rough conditions like strong currents and heavy winds. The system combines various technologies like a floating solar, wind farm, and battery storage. The system will also generate green hydrogen via an electrolyzer that can be used as a further storage technique [80]. The offshore green hydrogen production using combined wind and floating solar has great development potential. The ships can be refueled with hydrogen at these infrastructures. The solar island at sea can offer the shipping industry with a sustainable alternative.



Figure 13. Offshore floating solar, wind, and green hydrogen (Source ©: Acciona).

4.11. Floating Solar Methanol Island

An energy island consists of a multipurpose floating platform including several sustainable energy generation options [81]. A concept of “solar methanol island” based on offshore floating PV is proposed for H_2 production and CO_2 extraction from the seawater. The catalytic reaction produces synthetic MeOH fuel [82]. The operating conditions for

large-scale solar methanol islands are determined by engineering analyses and optimizations. The operating conditions for large-scale solar methanol islands are determined by engineering analyses and optimizations. The islands provide power to a centralized site, which includes desalination and electrolysis cells for H₂ processing, electrochemical cells for CO₂ extraction, and catalytic reactors and associated equipment for methanol production and separation, all of which are placed on a rigid boat [81]. Other island components include batteries for short-term electrical energy storage, a methanol storage tank, and miscellaneous equipment and furnishings.

4.12. Hybrid Floatovoltaic-Aquaculture System

Aquaculture is the most promising economic sector as it contributes to the global food supply industry. To realize the concept of aquavoltaics, the FPV model is integrated with aquaculture [23]. Integrated offshore floating platforms provide additional business opportunities as it enhances the production of aquatic species. The energy generated from the FPV system can be used to meet the off-grid aquaculture potential. Aquavoltaics' purpose is to make efficient use of water by using it for both energy and food generation [23]. However, several concerns of such a system including, biofouling, FPV interaction with aquatic ecosystems, political and regulatory issues are not well understood by the scientific community.

4.13. Floating Photo-Thermal (FPT) + Seawater Desalination

Island communities suffer in terms of potable water supply as the underlying water is salty. The seawater desalination process requires a lot of energy which may be difficult to meet in offshore site conditions. For solar energy applications, the solar-seawater nexus is crucial. Photothermal devices are solar concentrators/receivers which can be used for desalination by the production of low-temperature water vapor followed by condensation of vapor from the seawater [83]. Given, a large amount of footprint associated with the use of PV and PT for water desalination, a combination of FPV and FPT solutions is an attractive option to drive the seawater desalination process [84]. Costs of technology, design constraints, implementation needs, and optimization of the design will determine the future development in this important domain [84].

5. Hybrid FPV: Potential, Recent Developments, and Performance Aspects

5.1. Potential

Mankind has built thousands of dams and water reservoirs to provide drinking water to towns and cities, flood control to avert disasters, locks and dams to navigate rivers and streams to transport goods and services. Hydropower has held a key role in the global power system since the advent of centralized power distribution systems. Since the late 1800s, the earliest (but still operational) hydropower plants have been in operation. Hydropower is the largest energy source that helps with flood control, water management, entertainment, and grid stability.

In hydropower plants, the evaporation of water from reservoirs is a major loss since the water vapor cannot be used to produce energy by the turbine. Hydropower has a significant environmental impact, that destroys natural habitat, in the upstream and downstream part of the reservoir [68].

Hydropower plants, which generate electricity by harnessing the force of falling water, are almost operating in every part of the world. The total installed capacity of Hydropower in various countries is shown in Figure 14. Hydropower installed capacity reached 1308 gigatonnes (GW) in 2019, with generation reaching a new peak of 4306 terawatt-hours (TWh). Among them, 328 GW are run-of-the-river plants (e.g., hydropower plants without storage reservoirs) and 138.7 GW of hydro pumped storage capacity [69]. Hydropower plants are already a significant component of the global energy mix which accounts for 53% of all operational renewable energy sources worldwide, with wind power accounting for 24%, and solar about 18%.

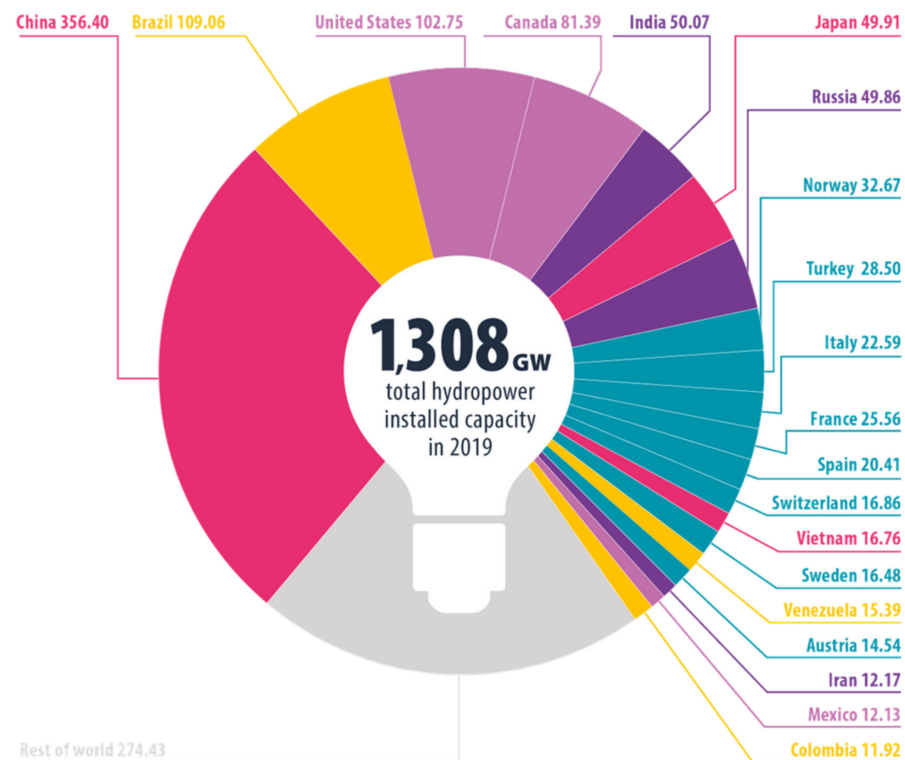

Figure 14. Total installed hydropower capacity (Source: International Hydropower Association, 2020).

According to a World Bank study, the global potential for floating solar power plants on man-made reservoirs is at least 400 GW. National Renewable Energy Laboratory (NREL) estimates that 379,068 freshwater reservoirs around the globe have the capacity to install floating panels on the existing hydropower facilities. In the case of large hydropower plants with dams, their electricity generation capacity can be matched by covering between 1–30% of the reservoir with floating solar panels. Even if coverage is limited to 10%, the increase in energy generation is substantial, and in some cases, it may be significantly higher than the hydropower production itself. This value is higher in equatorial zones with higher solar energy yield and lowers in high latitudes. As a consequence of significant hydro potential, the prospects of combining FPV and HPP plants are very much huge.

5.2. Recent Developments in Selected Countries

The majority of current commercial projects on hydropower reservoirs are co-located options. Only a few small projects with hybrid operations are currently in operation. However, many larger-scale projects are being explored or proposed around the world. Table 2 summarizes few hybrid FPV plant which is under operations/construction.

5.3. Industrial Players

Several technology developers are capitalizing on the momentum behind the floating solar plant by integrating other offshore energy systems into the mix to meet a sizable portion of the world's current electricity requirements [85]. Several developers around the world are also attempting to capitalize on the popularity of floating solar with hydropower plants. Table 3 provides a summary of the major players in the hybrid floating PV system power concepts. If development teams could perhaps efficiently design cost-effective hybrid concepts, HFPV could be a driving force for future installation than standard floating solar PV.

Table 2. Status of hybrid FPV plant worldwide (not exhaustive).

Project Name/Country	Floating Capacity	Developer/Owner	Investment/Revenue	Status
Sirindhom, Thailand	45 MW	EGAT, 2020	THB 842 million	Under construction
Magat, Philippines	200 KW (360 MW hydro)	Ocean Sun, GCL-SI and SN Aboitiz Power (SNAP), 2019	0.4 million dollars	Pilot testing
Alto Rabagao, Portugal	220 KWp (68 MW hydro)	Ciel & Terre International, 2017	Not available (N/A)	Operational
Bahia, Brazil	1 MWp (175 MW hydro)	Ciel & Terre International, 2019	N/A	Operational
Banja, Albania	2 MWp (73 MW hydro)	Ocean Sun, Statkraf	2.61 million dollars	Under construction
Kutani Dam, Japan	4.99 MWp	Japanese public enterprise agencies	5.4 million dollars	Operational
Nizhne-Bureyskaya, Russia	1.2 MW	Hevel Group and RusHydro, 2019	N/A	Operational

Table 3. Selected Industrial players in Hybrid FPV.

S.No.	Industry	Technology	Product Capacity	Remarks
1	Industry group Ocean Energy Europe Floating Power Plant of Denmark, Marine Power Systems of the U.K. and Pelagic Power of Norway	Floating wind turbine platform	N/A	Conceptual stage
2	U.S.-based Excipio Energy	Integrated wind, wave, flow, and ocean thermal energy conversion technologies	10 MW Offshore wind + 19MW other alternative energy	Yet to be tested.
3	Sinn Power Germany	Floating solar with offshore wind energy converter	5 MW	Modular approach for underwater use
4	Cantabria Sea of Innovation Cluster (SICC) & Acciona	Floating PV/wind with offshore green hydrogen generation	N/A	R & D project on a pilot scale
5	Equinor, Moss Maritime and Saipem	Floating offshore solar farm + Oil and gas or wind farm	24 MW	Commercial modular design
6	Madrid based ACCIONA	Floating solar, wind, and offshore green hydrogen	N/A	R& D project on a pilot scale

5.4. Performance Indicators of Hybrid FPV

There is a great debate among the scientific community concerning the use of an appropriate scientific approach to evaluate the performance of the systems. Figure 15 shows the important indicators which may be considered for measuring the HFPV performance. The sustainability indicator (SI) is developed as a tool to compare the electricity sector status of a region and country [85]. The performance of the projects can be analyzed based on NPV, LCOE, CF, and EY [86].

The NPV is the total present value of the project, which includes all projected expenses and returns through year one. Internal rate of return (IRR) provides the rate of return from the NPV cashflows obtained from the investments. Energy yield (EY) is defined as energy delivered by the FPV systems in terms of the peak power of the module. The LCOE of a renewable energy project is calculated by dividing the project's total cost by the amount of electricity generated. The LCOE is a parameter that allows for the comparison of alternative technologies at various operational scales, investment levels, and operating

periods [87]. LCOE can be used to compare different alternatives of HFPV. A good indicator of the cost-effectiveness of a particular generation and storage mix. The CF is an important performance evaluation parameter that displays the ratio of actual energy generated (E) by a system to the maximum energy the system can generate at any given time. Greenhouse gas (GHG) mitigation potential is used as an indicator to evaluate the CO₂ emissions reduction with the proposed technology compared to the conventional energy generation. In terms of social benefits, solar systems are expected to increase the standard of living and create job opportunities for locals [88,89]. It is worth noting that the aforementioned indicators do not account for the influence of combined parameters in arriving at a common value.

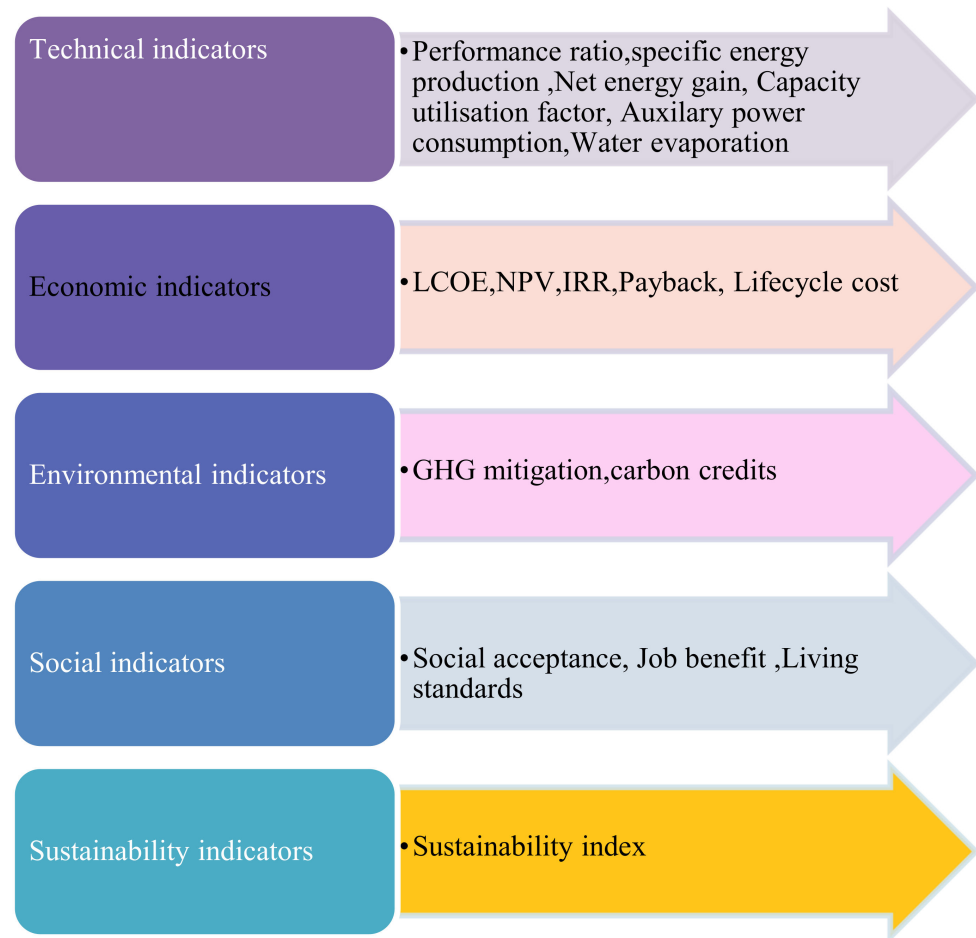

Figure 15. Performance indicators of Hybrid FPV system.

6. Positive Implications, Constraints, and Special Consideration of Hybrid FPV

In addition to generation, a hybrid FPV may provide the following advantages, especially when combined with existing hydropower.

6.1. Positive Implications of Hybrid Floating PV

- It promotes land-use efficiency. Since the floating PV energy systems are mounted on water, the land can be used for other useful purposes [86]. It does not necessitate any land construction or conversion of forest or farmland for solar power facilities [90]. It protects the land's original uses, such as forests, agriculture, livestock, and nature [91]. Utility-scale solar PV frequently necessitates large parcels of land; however, land-constrained developing countries may have to prioritize land use for agricultural, forestry, or other purposes [92]. By co-locating solar PV systems on artificial water bodies such as reservoirs, FPV may offer alternatives to scaling up renewables and reducing competing land-use pressures [65]. A close-to-zero strategy for locating

new PV plants without invading natural greenery while also protecting dams from insulation [37].

- Forest and farmland conservation: The main benefit of hybrid FPVs is that they do not require any agricultural or green space. They address the energy-water-land nexus issue. Land use is kept to a minimum. PV modules are installed on the existing water infrastructure (dam, ocean etc), which reduces the amount of land required [93].
- Increased energy efficiency. Due to its cooling effect and reduced water evaporation from hydropower generation, energy efficiency is improved by 10–15% when compared to land-based solar systems [86]. Water cooling beneath the panels improves system performance [66].
- Increased utilization rates of transmission lines / grid access: In general, hydro plants are easily accessible and already connected to the grid, so installing hybrid FPV requires fewer tasks and a power grid [94]. A hybrid system, for example, would save financial resources on transmission by connecting to a common substation [95]. Hydropower sites make use of existing electricity transmission facilities, and they're close to demand centers (in the case of water supply reservoirs. The hydropower plant's existing road access likely reduces construction and transportation costs.
- Provides high-energy yield. The increased energy generation is due to the water's natural cooling effect, which reduces temperature rises in the solar modules [96]. In comparison to a conventional installation on a flat surface, PV panels mounted on an inclined surface, minimizes the distance between two panels and thereby rising solar energy generation [97]. The surface of the water offers areas that are free of shading objects. as well as increased sunlight reflection, which improves PV generation. Due to the cooling action of water and the lack of dust, the energy yield also increases [98].
- Increased capacity utilization. The capacity factor of a hydroelectric power plant is the ratio of the total produced energy to the maximum energy that could be provided. If the hydro plant worked at its maximum installed power capacity all of the time, and floating modules would dramatically increase the installed capacity of a hydroelectric power plant by 50% to 100%. In existing dams, hybrid hydropower-connected F-PV plants (operation of FPV and hydropower together) could offset the loss of electrical production due to variations in water levels [99].
- Saves water resources. Because the floating PV system blocks the sunlight and covers the water surface, it reduces by more than 80% of the evaporation of water in the reservoir [10,68] The hybrid operation of the dams with FPV will enable appropriate and cost-effective management of power and water usage, as well as water savings due to less evaporation from the reservoir [100].
- Uses an eco-friendly system. Natural fish farms may continue to thrive on the platform. They create breeding sites for fish, increase aquatic plants, and reduce algae and microorganism levels.
- Lower capital expenditure (CAPEX): Because of the existing grid infrastructure, hydro-FPV-Hybrid has a lower CAPEX, but it is subject to specific site characteristics. When co-located with hydropower, the power system benefits and capital costs are reduced due to lower interconnection costs.
- Decreased CO₂ emissions. The hybrid floating solar farms has a higher potential to reduce the amount of carbon emissions than standard FPV. The HFPV system reduces CO₂ emissions per kWh produced, which is especially beneficial in tropical regions.
- Modernization of existing infrastructure. There exists an opportunity to modernize and improve the old infrastructure for the safety, reliability, and performance of the plant [93]. Furthermore, by using the same grid connection, hybrid F-PV and hydropower plants could reduce grid integration costs.
- Operational Flexibility and Dispatchable generation. Plants have the flexibility to operate on-demand with adjustable power output [101]. This is advantageous in countries with a weaker grid as the share of power is extracted from the variable, non-dispatchable solar energy [92,93]. Solar power can be used to boost the energy

yield of such facilities while also assisting in the management of low water availability by enabling the hydropower plant to run in “peaking” rather than “baseload” mode, with mutual benefits: Hydropower can smooth out variable solar performance by working in a “load-following” mode [102].

- Increased water quality. It improves water quality and allows to regenerate contaminated or non-productive water bodies [103]. Phytoplankton growth and water loss are reduced by the shading offered by PV panels on the water, resulting in increased hydro energy generation and water quality [67].
- Dam protection. PV panels protect the dam surface from direct solar radiation, which can weaken the dam’s stability, by reducing thermal excursion and increasing dam stability [72].
- Storage opportunity: Gravity energy storage is naturally indicated by the presence of water, particularly in conjunction with hydroelectric basins [69]. PV energy can be used to power pumps in pumped-storage hydropower plants [71]. In one scenario, hybrid system operators could use pumped storage hydropower to store excess solar generation.
- Increased market potential. This form of combined hybrid FPV plant potential and business opportunities are expected to advance in the future particularly in parts of Asia [104].
- Reducing seasonal variations: Combining floating PV with hydropower has the potential to provide additional benefits [105]. Furthermore, the two technologies can complement one another. During the dry seasons, solar power has the greatest potential, whereas hydropower has the greatest potential during rainy seasons. It can facilitate black-start capabilities for hydro [92]. This is valid not only during the diurnal period (when solar energy is used during the day and hydropower is used at night), but also during the seasons.
- The method of generating power using solar panels kept on water bodies differs from that used on conventional solar farms, where panels are arranged in a rectangular pattern. They have some advantages over land-based systems.

6.2. Constraints and R & D Challenges of Hybrid Floating Technology

- Cost of the technology: Hybrid floating solar installations necessitate specialized equipment which may increase the cost than traditional land-based installations. The costs of floating solar panels are high due to the stringent module requirements, but the costs are expected to fall as technology develops [106].
- Significant water level variation: Water level variations in hydro dams in hot tropical regions (by up to 10 feet) pose a significant technical risk.
- Complex mooring system: The requirement of a complex mooring system for HFPV is a significant limitation. It is unable to withstand heavy high winds, warranting a huge proportion of mooring points to keep it intact [35]. The occurrence of flash floods necessitates careful mooring/anchoring to avoid panel destruction [107].
- Detrimental effects of wind, wave, current, and snow: Microcracks in the solar cells are possible as a result of the constant bobbing movement beneath. Wind, wave, current, and snow have negative effects on the stability and long-term performance of HFPV systems [40].
- Limitation of coverage: The system suffers from the limitation of the water surface that can be covered. Normally 1–10% is covered to reduce environmental impact and Installation restriction on the littoral zone where aquatic life is abundant [108]. The space requirements for leisure and recreational activities pose the challenge of coverage.
- Seasonal variations of weather: The key disadvantage of hydropower-based hybrid FPV is that they are restricted to particular geographical areas. Most hydro plants are used as peaking plants which are highly influenced by monsoon seasons [109]. During

some periods of the year, certain reservoirs may be dry or otherwise unsuitable for accommodating hybrid floating PV.

- **Joint implementation:** The full potential and advantages of joint implementation of the hybrid system are not fully realized by the industry including the operations, scheduling, and optimization.
- **Limited experience and knowledge:** The current knowledge gap on hybrid FPV systems will inhibit data-driven decision-making. Limited experience with hybrid floating solar/hydropower systems. More specialized installation knowledge is required as this is a unique innovation.
- **Larger installations, across different geographies, and over time** are needed to validate the extent of these benefits associated, and they can exceed any rise in capital cost in many cases.
- **Because of the social and environmental implications of hydropower development,** it's fair to conclude that further application of FPV on dam surfaces would necessitate extensive discussion and review to enforce compliance with societal values [39].
- **Lack of guidelines and policies:** Inconsistent and very hostile policies for installations are the major drawback of the HFPV system.

Further R&D must be focused on lower-cost design, the choice of the floating structure, efficient mooring system, optimal sizing, material capable of selective emissivity, the thermal and fluid dynamic of the HFPV design to take advantage of these lower ambient and water temperatures.

6.3. Special Considerations

The following specific factors might be taken into considerations while going to hybridization of FPV plants:

- Willingness of the FPV owner/developers to add a hybrid installation;
- Development of the right framework and contractual agreement between various parties.
- Concessional agreement between the FPV plant owner/operator and a third party to construct, operate, and maintain an HFPV facility.
- Management of risks and liabilities associated with hybrid power plant and extreme weather that can influence plant performance;
- Rules of dispatch coordination of power from two individual sources (For instance: Floating solar and the hydropower plants' outputs).
- Creating insurance plans to cover future power plant loss risks.
- IOT based Intelligent monitoring to facilitate the operation, maintenance, and management of the HFPV system.

7. Conclusions and Future Perspective

This paper investigated various hybrid floating PV technologies that could be integrated with the existing FPV. Nevertheless, the development of basic concepts of hybrid FPV systems is carried out here which is still at an early stage. These technologies include FPV + hydro, FPV + pumped hydro, FPV + Wave energy converter, FPV + hydrokinetic + water lily tree, and FPV + conventional plant. This paper also presented the significant drivers, potential, and benefits of the hybrid FPV technology. The following are the key inference from the study:

- Hybrid FPV systems represent an alternate solution to increase the technological and economic competitiveness of FPV installations which may have a more positive impact than floating PV systems. Overall, a hybrid solar-floating system will be an alternative efficient method of power generation as compared to the standard floating system for power generation.
- Hybrid FPV has massive growth potential along with the upcoming technologies, such as offshore wind, tidal, wave, and aquavoltatics, integrating wind, wave, tidal,

or thermal energy systems into floating solar plants is anticipated to increase their prospects by offering efficient dual-mode power plants.

- Hybrid floating photovoltaic designs especially in hydro dams, have a tremendous implementation potential in island nations to meet their energy demand.
- The world is endowed with huge potential for HFPV. Hybrid FPV is a most sustainable technological solution that promises to address the water-energy nexus and provide a low-carbon pathway of energy generation. If the global potential of the HFPV is fully utilized, it may bring the world closer to decarbonization.
- The increased importance of hybridization of FPV for clean energy generation needs to be stressed among policymakers and various stakeholders.
- More pilot studies and innovative approaches are needed in the future for the less established technologies like hybrid FPV to achieve scale, cost reduction, energy yield, and high return on Investment. This will help to evaluate the various floating hybrid options' advantages and disadvantages, as well as their future implementation.
- The various insights presented on hybrid options, benefits, constraints, and special requirements of the Hybrid FPV plant will support the future R & D and pilot-scale deployment of HFPV plants worldwide.

Author Contributions: Conceptualization, E.S. (Evgeny Solomin), E.C. and S.K.; Data curation, E.S. (Evgeny Solomin); Formal analysis, E.C., S.K.; Investigation, E.S. (Evgeny Sirotkin); Methodology, S.K.; Project administration E.S. (Evgeny Solomin) and S.K.; Resources, S.K.; Supervision, E.S. (Evgeny Solomin); Validation, S.K.; Visualization, E.S. (Evgeny Solomin); Writing—original draft, S.P.S. and E.S. (Evgeny Sirotkin); Writing—review & editing, S.K., E.C., E.S. (Evgeny Sirotkin). All of the authors contributed significantly to the completion of this manuscript, conceiving and designing the research, writing, and improving the paper. All authors have read and agreed to the published version of the manuscript.

Funding: This research received no external funding.

Institutional Review Board Statement: Not applicable.

Informed Consent Statement: Not applicable.

Data Availability Statement: No new data were created or analyzed in this study. Data sharing is not applicable to this article.

Acknowledgments: This work was part of joint collaborative work carried out by South Ural State University (SUSU) and Universiti Malaysia Pahang (UMP). The authors acknowledge the support of both the universities for this research work. In particular, the presented research was funded by the Russian Foundation for Basic Research, Agreement RFBR #20-48-740002_a_Chelyabinsk on the base of Project-Training Education at South Ural State University (National Research University).

Conflicts of Interest: The authors declare no conflict of interest.

References

1. Perera, H.D.M.R. Designing of 3MW Floating Photovoltaic Power System and its Benefits over Other PV Technologies. *Int. J. Adv. Sci. Res. Eng.* **2020**, *6*, 37–48. [[CrossRef](#)]
2. Sreenath, S.; Sudhakar, K.; Yusop, A.F.; Solomin, E.; Kirpichnikova, I.M. Solar PV energy system in Malaysian airport: Glare analysis, general design and performance assessment. *Energy Rep.* **2020**, *6*, 698–712. [[CrossRef](#)]
3. Pimentel Da Silva, G.D.; Branco, D.A.C. Is floating photovoltaic better than conventional photovoltaic? Assessing environmental impacts. *Impact Assess. Proj. Apprais.* **2018**, *36*, 390–400. [[CrossRef](#)]
4. Joint, J.R.C. Photovoltaic Electricity. In *Submerged and Floating Photovoltaic Systems*; Academic Press: Cambridge, MA, USA, 2018; pp. 13–32. [[CrossRef](#)]
5. Karpouzoglou, T.; Vlaswinkel, B.; Van Der Molen, J. Effects of large-scale floating (solar photovoltaic) platforms on hydrodynamics and primary production in a coastal sea from a water column model. *Ocean Sci.* **2020**, *16*, 195–208. [[CrossRef](#)]
6. Dwivedi, P.; Sudhakar, K.; Soni, A.; Solomin, E. Case Studies in Thermal Engineering Advanced cooling techniques of P.V. modules: A state of art. *Case Stud. Therm. Eng.* **2020**, *21*, 100674. [[CrossRef](#)]
7. Junianto, B.; Dewi, T.; Sitompul, C.R. Development and Feasibility Analysis of Floating Solar Panel Application in Palembang, South Sumatra Development and Feasibility Analysis of Floating Solar Panel Application in Palembang, South Sumatra. *J. Phys. Conf. Ser.* **2020**, *1500*, 012016. [[CrossRef](#)]

8. Spencer, R.S.; Macknick, J.; Aznar, A.; Warren, A.; Reese, M.O. Floating Photovoltaic Systems: Assessing the Technical Potential of Photovoltaic Systems on Man-Made Water Bodies in the Continental United States. *Environ. Sci. Technol.* **2019**, *53*, 1680–1689. [[CrossRef](#)]
9. Sreenath, S.; Sudhakar, K.; Yusop, A.F. Solar PV in the airport environment: A review of glare assessment approaches & metrics. *Solar Energy* **2021**, *216*, 439–451. [[CrossRef](#)]
10. Abdelal, Q. Floating PV; an assessment of water quality and evaporation reduction in semi-arid regions. *Int. J. Low-Carbon Technol.* **2021**, *2021*, 1–8. [[CrossRef](#)]
11. Ramkiran, B.; Sundarabalan, C.K.; Sudhakar, K. Performance evaluation of solar PV module with filters in an outdoor environment. *Case Stud. Therm. Eng.* **2020**, *21*, 100700. [[CrossRef](#)]
12. Liu, L.; Sun, Q.; Li, H.; Yin, H.; Ren, X.; Wennersten, R. Evaluating the benefits of Integrating Floating Photovoltaic and Pumped Storage Power System. *Energy Convers. Manag.* **2019**, *194*, 173–185. [[CrossRef](#)]
13. Choi, Y.; Choi, Y.; Suh, J.; Park, H.-D.; Jang, M.; Go, W.-R. Assessment of Photovoltaic Potentials at Buguk, Sungsan and Younggwang Abandoned Mines in Jeollanam-do, Korea. *J. Korean Soc. Miner. Energy Resour. Eng.* **2013**, *50*, 827–837. [[CrossRef](#)]
14. Kamuyu, W.C.L.; Lim, J.R.; Won, C.S.; Ahn, H.K. Prediction model of photovoltaic module temperature for power performance of floating PVs. *Energies* **2018**, *11*, 447. [[CrossRef](#)]
15. Barbuscia, M. Economic viability assessment of floating photovoltaic energy. *Work. Pap.* **2018**, *1*, 1–11.
16. Taye, B.Z.; Nebey, A.H.; Workineh, T.G. Design of floating solar PV system for typical household on Debre Mariam Island. *Cogent Eng.* **2020**, *7*, 1829275. [[CrossRef](#)]
17. Yadav, N.; Gupta, M.; Sudhakar, K. Energy assessment of floating photovoltaic system. In Proceedings of the 2016 International Conference on Electrical Power and Energy Systems (ICEPES), Bhopal, India, 14–16 December 2016; 2017; pp. 264–269. [[CrossRef](#)]
18. Sasmano, A.A.; Dewi, T. Eligibility Study on Floating Solar Panel Installation over Brackish Water in Sungsang, South Sumatra. *EMIT Int. J. Eng. Technol.* **2020**, *8*, 240–255. [[CrossRef](#)]
19. Dörenkämper, M.; Wahed, A.; Kumar, A.; de Jong, M.; Kroon, J.; Reindl, T. The cooling effect of floating PV in two different climate zones: A comparison of field test data from the Netherlands and Singapore. *Sol. Energy* **2021**, *214*, 239–247. [[CrossRef](#)]
20. Muhammad, A.; Muhammad, U.; Abid, Z. Potential of floating photovoltaic technology in Pakistan. *Sustain. Energy Technol. Assess.* **2021**, *43*, 100976. [[CrossRef](#)]
21. Lake, J.; Paš, S.; Akšamović, A.; Avdaković, S. Floating Solar Plants on Artificial Accumulations—Example of Jablanica Lake. In Proceedings of the 2018 IEEE International Energy Conference (ENERGYCON), Limassol, Cyprus, 3–7 June 2018. [[CrossRef](#)]
22. Setiawan, F.; Dewi, T.; Yusi, S. Sea Salt Deposition Effect on Output and Efficiency Losses of the Photovoltaic System; A case study in Palembang, Indonesia. *J. Phys. Conf. Ser.* **2019**, *1167*, 012028. [[CrossRef](#)]
23. Pringle, A.M.; Handler, R.M.; Pearce, J.M. Aquavoltaics: Synergies for dual use of water area for solar photovoltaic electricity generation and aquaculture. *Renew. Sustain. Energy Rev.* **2017**, *80*, 572–584. [[CrossRef](#)]
24. Cazzaniga, R.; Cicu, M.; Rosa-Clot, M.; Rosa-Clot, P.; Tina, G.M.; Ventura, C. Floating photovoltaic plants: Performance analysis and design solutions. *Renew. Sustain. Energy Rev.* **2018**, *81*, 1730–1741. [[CrossRef](#)]
25. Ferrer-Gisbert, C.; Ferrán-Gozálvez, J.J.; Redón-Santafé, M.; Ferrer-Gisbert, P.; Sánchez-Romero, F.J.; Torregrosa-Soler, J.B. A new photovoltaic floating cover system for water reservoirs. *Renew. Energy* **2013**, *60*, 63–70. [[CrossRef](#)]
26. Taboada, M.E.; Cáceres, L.; Graber, T.A.; Galleguillos, H.R.; Cabeza, L.F.; Rojas, R. Solar water heating system and photovoltaic floating cover to reduce evaporation: Experimental results and modeling. *Renew. Energy* **2017**, *105*, 601–615. [[CrossRef](#)]
27. Perez, M.; Perez, R.; Ferguson, C.R.; Schlemmer, J. Deploying effectively dispatchable PV on reservoirs: Comparing floating PV to other renewable technologies. *Sol. Energy* **2018**, *174*, 837–847. [[CrossRef](#)]
28. Liu, H.; Krishna, V.; Lun Leung, J.; Reindl, T.; Zhao, L. Field experience and performance analysis of floating PV technologies in the tropics. *Prog. Photovolt. Res. Appl.* **2018**, *26*, 957–967. [[CrossRef](#)]
29. Durković, V.; Durišić, Ž. Analysis of the potential for use of floating PV power plant on the skadar lake for electricity supply of aluminium plant in Montenegro. *Energies* **2017**, *10*, 1505. [[CrossRef](#)]
30. Choi, Y. A Case Study on Suitable Area and Resource for Development of Floating Photovoltaic System. *Int. J. Electr. Comput. Electron. Commun. Eng.* **2014**, *8*, 816–820. [[CrossRef](#)]
31. Trapani, K.; Millar, D.L. Proposing offshore photovoltaic (PV) technology to the energy mix of the Maltese islands. *Energy Convers. Manag.* **2013**, *67*, 18–26. [[CrossRef](#)]
32. Safarini, N.A.; Akash, O.; Mohsen, M.; Iqbal, Z.; Am, D.T.; Goswami, A.; Sadhu, P.K.P.; Goswami, U.; Sadhu, P.K.P.; Sukarso, A.P.; et al. A study on power generation analysis of floating PV system considering environmental impact. *Energy Procedia* **2019**, *8*, 1–6. [[CrossRef](#)]
33. Nagavinothini, R.; Chansrasekaran, S. Dynamic analyses of offshore triceratops in ultra-deep waters under wind, wave, and current. *Structures* **2019**, *20*, 279–289. [[CrossRef](#)]
34. Sreenath, S.; Sudhakar, K.; Yusop, A.F. 7E analysis of a conceptual utility-scale land-based solar photovoltaic power plant. *Energy* **2021**, *219*, 119610. [[CrossRef](#)]
35. Piana, V.; Kahl, A.; Saviozzi, C.; Schumann, R. Floating PV in mountain artificial lakes: A checklist for site assessment. *Renew. Energy Environ. Sustain.* **2021**, *6*, 4. [[CrossRef](#)]
36. Sahu, A.; Yadav, N.; Sudhakar, K. Floating photovoltaic power plant: A review. *Renew. Sustain. Energy Rev.* **2016**, *66*, 815–824. [[CrossRef](#)]

37. Sreenath, S.; Sudhakar, K.; Yusop, A.F. Airport-based photovoltaic applications. *Prog. Photovoltaics Res. Appl.* **2020**. [[CrossRef](#)]
38. Friel, D.; Karimirad, M.; Whittaker, T.; Doran, J.; Howlin, E. A review of floating photovoltaic design concepts and installed variations. In *CORE 2019 Proceedings, Proceedings of the 4th International Conference Offshore Renew Energy, Glasgow, UK, 29–30 August 2019*; ASRANet Ltd.: Glasgow, UK, 2019.
39. Nagananthini, R.; Nagavinothini, R. Investigation on floating photovoltaic covering system in rural Indian reservoir to minimize evaporation loss. *Int. J. Sustain. Energy* **2021**. [[CrossRef](#)]
40. Nagananthini, R.; Nagavinothini, R.; Balamurugan, P. Floating photovoltaic thin film technology—A review. In *Intelligent Manufacturing and Energy Sustainability*; Springer: Singapore, 2020; Volume 169, pp. 329–338.
41. Oliveira-Pinto, S.; Stokkermans, J. Assessment of the potential of different floating solar technologies—Overview and analysis of different case studies. *Energy Convers. Manag.* **2020**, *211*, 112747. [[CrossRef](#)]
42. Clot, M.R.; Rosa-Clot, P.; Tina, G.M. Submerged PV Solar Panel for Swimming Pools: SP3. *Energy Procedia* **2017**, *134*, 567–576. [[CrossRef](#)]
43. Tina, G.M.; Rosa-Clot, M.; Rosa-Clot, P.; Scandura, P.F. Optical and thermal behavior of submerged photovoltaic solar panel: SP2. *Energy* **2012**, *39*, 17–26. [[CrossRef](#)]
44. Trapani, K.; Millar, D. Hydrodynamic Overview of Flexible Floating Thin Film PV Arrays. In *Proceedings of the 3rd Offshore Energy and Storage Symposium, Valletta, Malta, 13–15 July 2016*; pp. 3–6.
45. Azmi, M.S.M.; Othman, M.Y.H.; Ruslan, M.H.H.; Sopian, K.; Majid, Z.A.A. Study on electrical power output of floating photovoltaic and conventional photovoltaic. *AIP Conf. Proc.* **2013**, *1571*, 95–101. [[CrossRef](#)]
46. Hooper, T.; Armstrong, A.; Vlaswinkel, B. Environmental impacts and benefits of marine floating solar. *Sol. Energy* **2021**, *219*, 11–14. [[CrossRef](#)]
47. Kandlakunta, L.C.; Deshmukh, M.K.; Sharma, N. Materials Today: Proceedings Assessment of impacts on tropical marine environment for off-shore clean energy development. *Mater. Today Proc.* **2020**, *23*, 53–55. [[CrossRef](#)]
48. Diendorfer, C.; Haider, M.; Lauer mann, M. Performance analysis of offshore solar power plants. *Energy Procedia* **2014**, *49*, 2462–2471. [[CrossRef](#)]
49. Wu, Y.; Li, L.; Song, Z.; Lin, X. Risk assessment on offshore photovoltaic power generation projects in China based on a fuzzy analysis framework. *J. Clean. Prod.* **2019**, *215*, 46–62. [[CrossRef](#)]
50. Campana, P.E.; Wästhage, L.; Nookuea, W.; Tan, Y.; Yan, J. Optimization and assessment of floating and floating-tracking PV systems integrated in on- and off-grid hybrid energy systems. *Sol. Energy* **2019**, *177*, 782–795. [[CrossRef](#)]
51. Choi, Y.-K.; Lee, N.-H.; Lee, A.-K.; Kim, K.-J. A study on major design elements of tracking-type floating photovoltaic systems. *Int. J. Smart Grid Clean Energy* **2014**, *3*, 70–74. [[CrossRef](#)]
52. Ranjbaran, P.; Yousefi, H.; Gharehpetian, G.B.; Astaraei, F.R. A review on floating photovoltaic (FPV) power generation units. *Renew. Sustain. Energy Rev.* **2019**, *110*, 332–347. [[CrossRef](#)]
53. Acharya, M.; Devraj, S. *Floating Solar Photovoltaic (FSPV): A Third Pillar to Solar PV Sector?* TERI Discussion Paper ETC India Project; The Energy and Resources Institute: New Delhi, India, 2019; p. 68.
54. Sahu, A.K.; Sudhakar, K. Effect of UV exposure on bimodal HDPE floats for floating solar application. *J. Mater. Res. Technol.* **2019**, *8*, 147–156. [[CrossRef](#)]
55. Kim, S.-H.; Lee, Y.-G.; Seo, S.-H.; Joo, H.-J.; Yoon, S.-J. Structural Design and Installation of Tracking-type Floating PV Generation System. *Compos. Res.* **2014**, *27*, 59–65. [[CrossRef](#)]
56. Redón Santafé, M.; Torregrosa Soler, J.B.; Sánchez Romero, F.J.; Ferrer Gisbert, P.S.; Ferrán Gozálviz, J.J.; Ferrer Gisbert, C.M. Theoretical and experimental analysis of a floating photovoltaic cover for water irrigation reservoirs. *Energy* **2014**, *67*, 246–255. [[CrossRef](#)]
57. Chico Hermanu, B.A.; Santoso, B.; Suyitno, W.; Rian, F.X. Design of 1 MWp floating solar photovoltaic (FSPV) power plant in Indonesia. *AIP Conf. Proc.* **2019**, *2097*, 030013. [[CrossRef](#)]
58. Do Sacramento, E.M.; Carvalho, P.C.M.; De Araújo, J.C.; Riffel, D.B.; Da Cruz Corrêa, R.M.; Neto, J.S.P. Scenarios for use of floating photovoltaic plants in Brazilian reservoirs. *IET Renew. Power Gener.* **2015**, *9*, 1019–1024. [[CrossRef](#)]
59. Reyes-Belmonte, M.A. Quo vadis solar energy research? *Appl. Sci.* **2021**, *11*, 3015. [[CrossRef](#)]
60. Lee, A.-K.; Shin, G.-W.; Hong, S.-T.; Choi, Y.-K. A study on development of ICT convergence technology for tracking-type floating photovoltaic systems. *Int. J. Smart Grid Clean Energy* **2013**, *3*, 80–87. [[CrossRef](#)]
61. Mayville, P.; Vijay, N.; Pearce, J.M. Distributed manufacturing of after market flexible floating photovoltaic modules. *Sustain. Energy Technol. Assess.* **2020**, *42*, 100830. [[CrossRef](#)]
62. Energy Sector Management Assistance Program; Solar Energy Research Institute of Singapore. *Where Sun Meets Water: Floating Solar Handbook for Practitioners*; World Bank: Washington, DC, USA, 2019. [[CrossRef](#)]
63. Singh, A.K.; Boruah, D.; Sehgal, L.; Ramaswamy, A.P. Feasibility study of a grid-tied 2MW floating solar PV power station and e-transportation facility using ‘SketchUp Pro’ for the proposed smart city of Pondicherry in India. *J. Smart Cities* **2017**, *2*, 49–59. [[CrossRef](#)]
64. López, M.; Rodríguez, N.; Iglesias, G. Combined Floating Off shore Wind and Solar PV. *J. Mar. Sci. Eng.* **2020**, *8*, 576. [[CrossRef](#)]
65. Golroodbari, S.Z.M.; Vaartjes, D.F.; Meit, J.B.L.; Van Hoeken, A.P.; Eberveld, M.; Jonker, H.; Sark, W.G.J.H.M. Van Pooling the cable: A techno-economic feasibility study of integrating offshore floating photovoltaic solar technology within an offshore wind park. *Sol. Energy* **2021**, *219*, 65–74. [[CrossRef](#)]

66. Nazir, C.P. Coastal power plant: A hybrid solar-hydro renewable energy technology. *Clean Energy* **2018**, *2*, 102–111. [[CrossRef](#)]
67. Ravichandran, N.; Ravichandran, N.; Panneerselvam, B. Performance analysis of a floating photovoltaic covering system in an Indian reservoir. *Clean Energy* **2021**, 208–228. [[CrossRef](#)]
68. Lee, N.; Grunwald, U.; Rosenlieb, E.; Mirlet, H.; Aznar, A.; Spencer, R.; Cox, S. Hybrid floating solar photovoltaics-hydropower systems: Benefits and global assessment of technical potential. *Renew. Energy* **2020**, *162*, 1415–1427. [[CrossRef](#)]
69. Farfan, J.; Breyer, C. Combining Floating Solar Photovoltaic Power Plants and Hydropower Reservoirs: Virtual Battery of Power Great Global Potential Combining Floating Solar Photovoltaic Plants and The 15th International Symposium on District Heatin. *Energy Procedia* **2018**, *155*, 403–411. [[CrossRef](#)]
70. Al-Masri, H.M.K.; Magableh, S.K.; Abuelrub, A.; Saadeh, O.; Ehsani, M. Impact of different photovoltaic models on the design of a combined solar array and pumped hydro storage system. *Appl. Sci.* **2020**, *10*, 3650. [[CrossRef](#)]
71. Mousavi, N.; Kothapalli, G.; Habibi, D.; Das, C.K.; Baniasadi, A. Modelling, design, and experimental validation of a grid-connected farmhouse comprising a photovoltaic and a pumped hydro storage system. *Energy Convers. Manag.* **2020**, *210*, 112675. [[CrossRef](#)]
72. Kougiass, I.; Bódis, K.; Jäger-Waldau, A.; Monforti-Ferrario, F.; Szabó, S. Exploiting existing dams for solar PV system installations. *Prog. Photovolt. Res. Appl.* **2016**, *24*, 229–239. [[CrossRef](#)]
73. Bhardwaj, B.; Bhardwaj, N. Hydrokinetic-Solar Hybrid Floating Renewable Energy Generation System to Explore Hydro and Solar Power Potential Worldwide. In Proceedings of the 2nd International Conference on Large-Scale Grid Integration of Renewable Energy in India, New Delhi, India, 4–6 September 2019; pp. 4–8.
74. Bugeja, S. Hybrid Floating Wind and Solar Plants for Small Island States and Remote Communities: Synergy or Wishful Thinking? An Exploratory Study on the Maltese Islands. Master's Thesis, Utrecht University, Utrecht, The Netherlands, 2020.
75. Cazzaniga, R.; Cicu, M.; Rosa-Clot, M.; Rosa-Clot, P.; Tina, G.M.; Ventura, C. Compressed air energy storage integrated with floating photovoltaic plant. *J. Energy Storage* **2017**, *13*, 48–57. [[CrossRef](#)]
76. Sato, Y.; Ohya, Y.; Kyojuzuka, Y.; Tsutsumi, T. *The Floating Offshore Wind Turbine with PC Floating Structure—Hakata Bay Floating Offshore Wind Turbine*; Kyushu University: Fukuoka, Japan, 2014.
77. Nordmann, T. Photovoltaics and the Lacustrine Landscape Large Scale Photovoltaik Hydro Electric on Water, PVSEC Amsterdam. 2014. Available online: https://www.tnc.ch/wp-content/uploads/2017/10/nordmann_eupvsec_2014_landscape.pdf (accessed on 21 February 2021).
78. Tofani, A.F.; Garniwa, I.; Fajry, F.R. Techno-Economic Analysis of Sea Floating PV/Diesel Hybrid Power Plant with Battery Arrangement Scheme for Residential Load at Remote Area in Indonesia (Case Study: Small Kei Island, South East Moluccas). In Proceedings of the 2018 International Conference on Electrical Engineering and Computer Science (ICECOS), Pangkal, Indonesia, 2–4 October 2018; pp. 2–6. [[CrossRef](#)]
79. Dedović, M.M.; Avdaković, S.; Mujezinović, A.; Dautbašić, N. Integration of PV into the Sarajevo Canton Energy System-Air Quality and Heating Challenges. *Energies* **2020**, *14*, 123. [[CrossRef](#)]
80. Temiz, M.; Javani, N. Design, and analysis of a combined floating photovoltaic system for electricity and hydrogen production. *Int. J. Hydrog. Energy* **2020**, *45*, 3457–3469. [[CrossRef](#)]
81. Roy, A.; Auger, F.; Dupriez-Robin, F.; Bourguet, S.; Tran, Q.T. Electrical power supply of remote maritime areas: A review of hybrid systems based on marine renewable energies. *Energies* **2018**, *11*, 1904. [[CrossRef](#)]
82. Patterson, B.D.; Mo, F.; Borgschulte, A.; Hillestad, M.; Joos, F.; Kristiansen, T.; Sunde, S.; van Bokhoven, J.A. Renewable CO₂ recycling and synthetic fuel production in a marine environment. *Proc. Natl. Acad. Sci. USA* **2019**, *116*, 12212–12219. [[CrossRef](#)] [[PubMed](#)]
83. Ni, G.W.; Li, G.; Boriskina, S.V.; Li, H.; Yang, W.; Zhang, T.; Chen, G. Steam generation under one sun enabled by a floating structure with thermal concentration. *Nat. Energy* **2016**, *1*, 16126. [[CrossRef](#)]
84. Skumanich, A. Considerations for the use of PV and PT for seawater desalination: The viability of floating solar for this application. In Proceedings of the 2020 47th IEEE Photovoltaic Specialists Conference (PVSC), Calgary, ON, Canada, 15 June–21 August 2020; IEEE: Piscataway, NJ, USA, 2020; pp. 0633–0635. [[CrossRef](#)]
85. Farfan, J.; Breyer, C. Structural changes of global power generation capacity towards sustainability and the risk of stranded investments supported by a sustainability indicator. *J. Clean. Prod.* **2017**, *141*, 370–384. [[CrossRef](#)]
86. Pouran, H.M. From collapsed coal mines to floating solar farms, why China's new power stations matter. *Energy Policy* **2018**, *123*, 414–420. [[CrossRef](#)]
87. Zubair, M.; Bilal Awan, A.; Ghuffar, S.; Butt, A.D.; Farhan, M. Analysis and Selection Criteria of Lakes and Dams of Pakistan for Floating Photovoltaic Capabilities. *J. Sol. Energy Eng.* **2020**, *142*, 1–11. [[CrossRef](#)]
88. Sukarso, A.P.; Kim, K.N. Cooling effect on the floating solar PV: Performance and economic analysis on the case of west Java province in Indonesia. *Energies* **2020**, *13*, 2126. [[CrossRef](#)]
89. Kabir, E.; Kim, K.; Szulejko, J.E. Social Impacts of Solar Home Systems in Rural Areas: A Case Study in Bangladesh. *Energies* **2017**, *10*, 1615. [[CrossRef](#)]
90. Liu, L.; Wang, Q.; Lin, H.; Li, H.; Sun, Q.; Wennersten, R. Power Generation Efficiency and Prospects of Floating Photovoltaic Systems. *Energy Procedia* **2017**, *105*, 1136–1142. [[CrossRef](#)]

91. Jamalludin, M.A.S.; Muhammad-Sukki, F.; Abu-Bakar, S.H.; Ramlee, F.; Munir, A.B.; Bani, N.A.; Muhtazaruddin, M.N.; Mas'ud, A.A.; Ardila-Rey, J.A.; Ayub, A.S.; et al. Potential of floating solar technology in Malaysia. *Int. J. Power Electron. Drive Syst.* **2019**, *10*, 1638–1644. [[CrossRef](#)]
92. Kumar, M.; Kumar, A. Experimental validation of performance and degradation study of canal-top photovoltaic system. *Appl. Energy* **2019**, *243*, 102–118. [[CrossRef](#)]
93. Golroodbari, S.Z.; van Sark, W. Simulation of performance differences between offshore and land-based photovoltaic systems. *Prog. Photovolt. Res. Appl.* **2020**, *28*, 873–886. [[CrossRef](#)]
94. Gadzanku, S.; Mirlletz, H.; Lee, N.; Daw, J.; Warren, A. Benefits and Critical Knowledge Gaps in Determining the Role of Floating Photovoltaics in the Energy-Water-Food Nexus. *Sustainability* **2021**, *13*, 4317. [[CrossRef](#)]
95. Solar, W.; Generation, P. *Volts from the Blue—Is Combined Floating Solar and Hydro the Energy Solution for ASEAN? Land-Scarce ASEAN Countries Are Perfectly Positioned to Benefit from Cost-Competitive Waterborne Solar Power Generation*; IEEFA: Lakewood, OH, USA, 2020; pp. 1–24.
96. Cazzaniga, R.; Rosa-Clot, M.; Rosa-Clot, P.; Tina, G.M. Integration of PV floating with hydroelectric power plants. *Heliyon* **2019**, *5*, e01918. [[CrossRef](#)] [[PubMed](#)]
97. Dahmoun, M.E.H.; Bekkouche, B.; Sudhakar, K.; Guezgouz, M.; Chenafi, A.; Chaouch, A. Performance evaluation and analysis of grid-tied large scale PV plant in Algeria. *Energy Sustain. Dev.* **2021**, *61*, 181–195. [[CrossRef](#)]
98. Zahedi, R.; Ranjbaran, P.; Gharehpetian, G.B.; Mohammadi, F.; Ahmadihangar, R. Cleaning of Floating Photovoltaic Systems: A Critical Review. *Energies* **2021**, *14*, 2018. [[CrossRef](#)]
99. Maués, J.A. Floating solar PV-hydroelectric power plants in Brazil: Energy storage solution with great application potential. *Int. J. Energy Prod. Manag.* **2019**, *4*, 40–52. [[CrossRef](#)]
100. Rosa-Clot, M.; Tina, G.M.; Nizetic, S. Floating photovoltaic plants and wastewater basins: An Australian project. *Energy Procedia* **2017**, *134*, 664–674. [[CrossRef](#)]
101. Stiubiener, U.; Carneiro da Silva, T.; Trigo, F.B.M.; Benedito, R.d.S.; Teixeira, J.C. PV power generation on hydro dam's reservoirs in Brazil: A way to improve operational flexibility. *Renew. Energy* **2020**, *150*, 765–776. [[CrossRef](#)]
102. Haas, J.; Khalighi, J.; Fuente, A.D.; Gerbersdorf, S.U.; Nowak, W.; Chen, P. Floating photovoltaic plants: Ecological impacts versus hydropower operation flexibility. *Energy Convers. Manag.* **2020**, *206*, 112414. [[CrossRef](#)]
103. Vreeburg, J. Potential impact of floating solar panels on water quality in reservoirs; pathogens and leaching. *Water Pract. Technol.* **2020**, *15*, 807–811. [[CrossRef](#)]
104. Kougiás, I.; Szabó, S.; Monforti-Ferrario, F.; Huld, T.; Bódis, K. A methodology for optimization of the complementarity between small-hydropower plants and solar PV systems. *Renew. Energy* **2016**, *87*, 1023–1030. [[CrossRef](#)]
105. Silvério, N.M.; Barros, R.M.; Tiago Filho, G.L.; Redón-Santafé, M.; Santos, I.F.S.d.; Valério, V.E.d.M. Use of floating PV plants for coordinated operation with hydropower plants: Case study of the hydroelectric plants of the São Francisco River basin. *Energy Convers. Manag.* **2018**, *171*, 339–349. [[CrossRef](#)]
106. Liu, H.; Kumar, A.; Reindl, T. *The Dawn of Floating Solar—Technology, Benefits, and Challenges*; Springer: Singapore, 2020; Volume 41, ISBN 9789811387432.
107. Whittaker, T.; Folley, M.; Hancock, J. *Environmental Loads, Motions, and Mooring Systems*; Elsevier Inc.: Amsterdam, The Netherlands, 2020; ISBN 9780128170618.
108. Armstrong, A.; Page, T.; Thackeray, S.J.; Hernandez, R.R.; Jones, I.D. Integrating environmental understanding into freshwater floatovoltaic deployment using an effects hierarchy and decision trees. *Environ. Res. Lett.* **2020**, *15*. [[CrossRef](#)]
109. Abdullah, W.S.W.; Osman, M.; Kadir, M.Z.A.A.; Verayiah, R. The potential and status of renewable energy development in Malaysia. *Energies* **2019**, *12*, 2437. [[CrossRef](#)]